



FA 20 504 06

P. 1 | 2

# Melixion-S



①



②









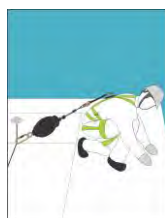
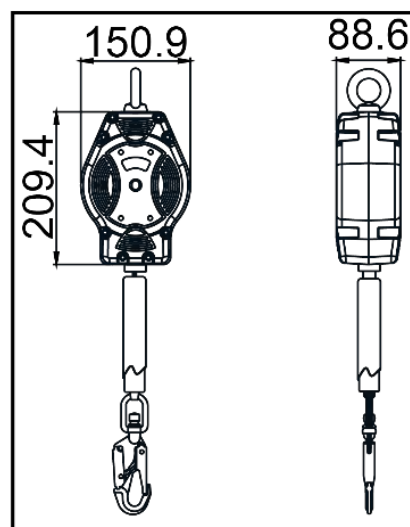

③



④



HS CODE
84798997
CARTON SIZE / PCS.
60 x 40 x 24 cm / 4
AET N°2777/10828-02/E01-01
Satra Technology Europe Ltd., N° 2777, Bracetown Business Park, Clonee, Dublin, D15YN2P, Ireland
MODULE D F114/14003.02
SGS Fimko Oy, N°0598 Takomotie 8, 00380 HELSINKI, Finland

<b>REF.</b>	<b>FA 20 504 06</b>
 <p>LG. KG</p>	6 m
<b>CE</b>	EN 360:2002
 <p>MAT.</p> 	Polyamide 6 - 30% fiber glass  PES 25 mm
	 FA 50 101 17 / FA 50 203 20 with fall indicator
	x2
<b>R(kN)</b>	15 kN
	YES
	3.21 KG



**Longueur** Poids maxi utilisateur  
**Length** Max. user weight  
**Longitud** Peso máximo del usuario  
**Lunghezza** Peso Max. dell'utente  
**Länge** Höchstgewicht des Benutzers

**MAT.**



**Matière carter / sangle**  
 Material of casing / webbing  
**Material cárter / correa**  
 Material dei carter / Cinghia  
**Material Gehäuse / Gurt**

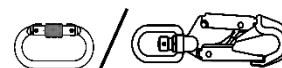

**Matière connecteur haut / connecteur bas**  
 Material of top connector / bottom connector  
**Material conector alto / conector bajo**  
 Materiale connettore alto / connettore basso  
**Material oberes / unteres Verbindungselement**



**Nombre d'émerillons**  
 Number of swivels  
**Cantidad de eslabones giratorios**  
 Numero di tornichetti  
**Anzahl der Wirbel**



**Homologué pour le travail à proximité d'arêtes vives**  
 Approved for work near sharp edges  
**Homologado para trabajo cerca de aristas vivas**  
 Omologato per lavoro in prossimità di spigoli vivi  
**Zugelassen für Arbeiten in der Nähe scharfer Kanten**